

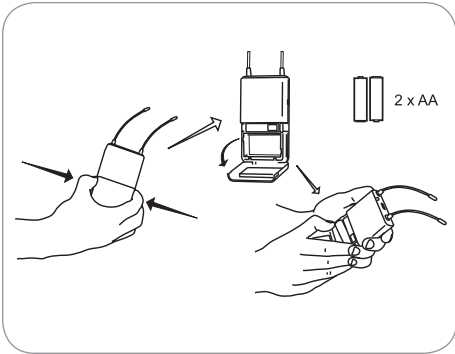





FP1 - FP5



FP2

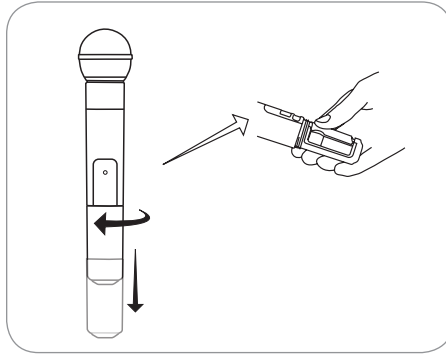

FP3

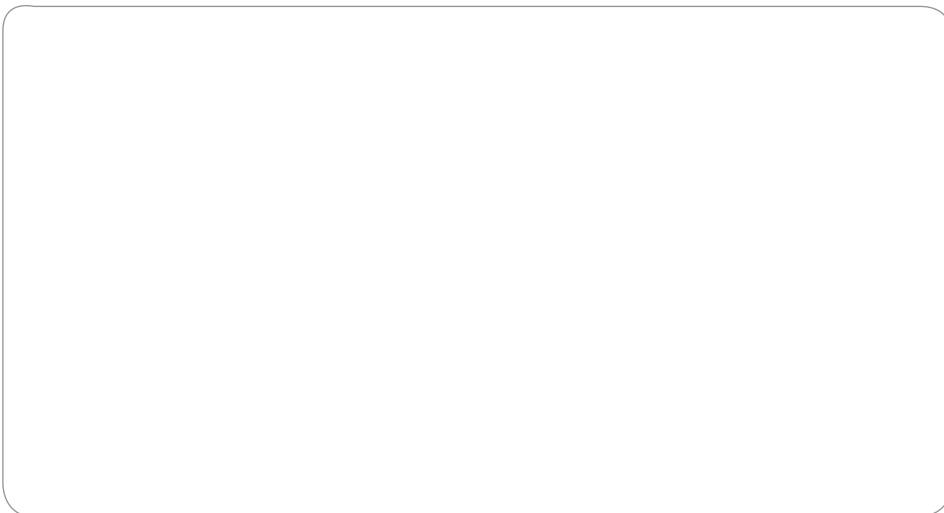
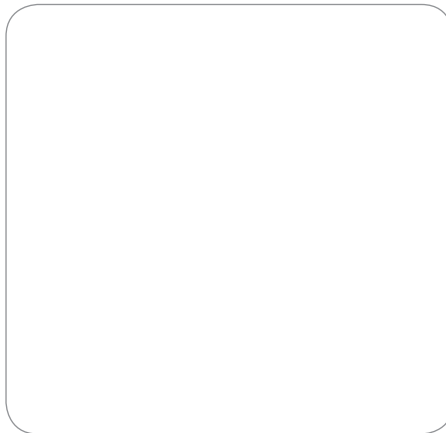
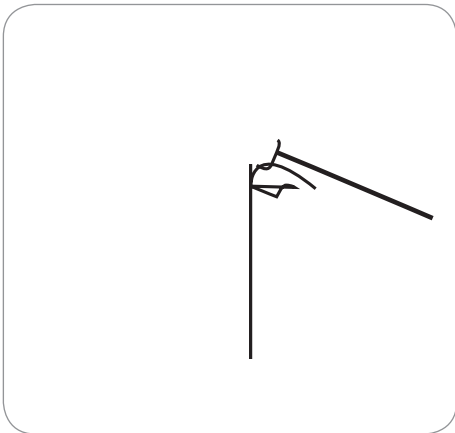
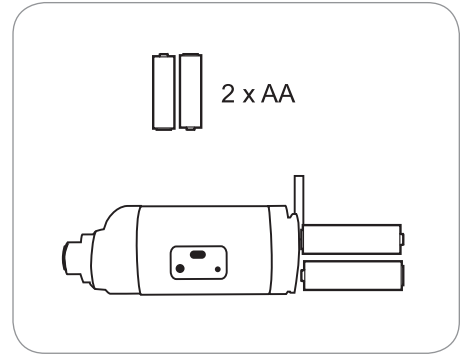



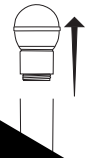



	100 (300 )
	32.768
	45 15000 (±2 dB)
	<0.5%,
	>100 dB, A-
	-18° C (0° F) +57° C (135° F)

	-10 +20 dBV
	1 M
	10 30 mW
TA4M	: ( ) : +5 : : ( ) 4
	108 mm x 64 mm x 19 mm ( x x )
	81 (3 ),
	LR6 , 1.5
	11 ( )

	-10 dB : +2 dBV 0 dB : -8 dBV
	10 dB
	10 30 mW
	/

G 4	470 - 494 MHz	30 mW
G 4E	470 - 494 MHz	10 mW
G5	494 - 518 MHz	30 mW
G5E	494 - 518 MHz	10 mW
H5	518 - 542 MHz	30 mW
H5E	518 - 542 MHz	10 mW
J3	572 - 596 MHz	30 mW
K 3E	606 - 630 MHz	10 mW
L4	638 - 662 MHz	30 mW
L4CN	638 - 662 MHz	30 mW
L4E	638 - 662 MHz	30 mW
P4	702 - 726 MHz	30 mW
P4CN	702 - 726 MHz	30 mW
Q24	736 - 754 MHz	30 mW
R13	794 - 806 MHz	20 mW
R19	794 - 806 MHz	10 mW
R5	800 - 820 MHz	20 mW
JB	806 - 810 MHz	10 mW
S6	838 - 865 MHz	10 mW
X4	925 - 932 MHz	10 mW

\* 50



B ICES-003 Cet appareil numérique de la classe B est conforme à la norme NMB-003 du Canada.

9 , EN60065. EN 300 422 1 2 , EN 301,489 1

- R&TTE 99/5/EC
- 2008/34/EC WEEE 2002/96/EC
- 2002/95/EC RoHS 2002/95/EC

FCC 74

DD4FP3L DD4FP3M DD4FP3A DD4FP3B DD4FP3C DD4SLX1G4 DD4SLX1G5 DD4SLX1 DD4SLX2G4 DD4SLX2G5 DD4SLX2

IC RSS-123 RSS-102

616A-FP3L 616A-FP3M 616A-FP3A 616A-FP3B 616A-FP3C 616A-SLX1G4 616A-SLX1G5 616A-SLX1 616A-SLX2G4 616A-SLX2G5 616A-SLX2

RSS

(1)

(2)

Le présent appareil est conforme aux CNR d'Industrie Canada applicables aux appareils radio exempts de licence. L'exploitation est autorisée aux deux conditions suivantes : (1) l'appareil ne doit pas produire de brouillage, et (2) l'utilisateur de l'appareil doit accepter tout brouillage radioélectrique subi, même si le brouillage est susceptible d'en compromettre le fonctionnement

15 (DoC)

IC RSS-123 RSS-102 616A-FP5L 616A-FP5M 616A-FP5A 616A-FP5B 616A-FP5C

www.shure.com

"CE

" www.shure.com/europe/compliance

Shure Europe GmbH

Jakob-Dieffenbacher-Str.12  
75031 Eppingen, Germany  
49-7262-92 49 0  
49-7262-92 49 11 4  
EMEAsupport@ shure.de

EMC

EMC

FCC

15

B



•  
•  
•  
•  
/



	518.400	519.250	518.200	519.775	519.100	518.425
	521.500	520.500	519.675	522.500	521.225	520.400
	523.575	522.225	520.800	524.200	522.550	523.425
	525.050	524.725	522.450	525.600	524.575	525.475
	527.425	526.350	523.750	526.700	526.900	527.775
	529.200	527.550	526.200	528.250	530.500	531.675
	532.450	530.800	528.325	529.500	531.750	533.800
	533.650	532.575	532.225	533.100	533.300	536.250
	535.275	534.950	534.525	535.425	534.400	537.550
	537.775	536.425	536.575	537.450	535.800	539.200
	539.500	538.500	539.600	538.775	537.500	540.325
	540.750	541.600	541.575	540.900	540.225	541.800
	Full Range - even distribution for each TV-CH	Full Range - even distribution for each TV-CH	Full Range - max. # of frequencies for CH- 22	Full Range - max. # of frequencies for CH- 23	Full Range - max. # of frequencies for CH- 24	Full Range - max. # of frequencies for CH- 25

	572.400	573.250	572.200	573.775	573.100	572.425
	575.500	574.500	573.675	576.500	575.225	574.400
	577.575	576.225	574.800	578.200	576.550	577.425
	579.050	578.725	576.450	579.600	578.575	579.475
	581.425	580.350	577.750	580.700	580.900	581.775
	583.200	581.550	580.200	582.250	584.500	585.675
	586.450	584.800	582.325	583.500	585.750	587.800
	587.650	586.575	586.225	587.100	587.300	590.250
	589.275	588.950	588.525	589.425	588.400	591.550
	591.775	590.425	590.575	591.450	589.800	593.200
	593.500	592.500	593.600	592.775	591.500	594.325
	594.750	595.600	595.575	594.900	594.225	595.800
	Full Range - even distribution for each TV-CH	Full Range - even distribution for each TV-CH	Full Range - max. # of frequencies for CH- 31	Full Range - max. # of frequencies for CH- 32	Full Range - max. # of frequencies for CH- 33	Full Range - max. # of frequencies for CH- 34

	638.400	639.250	638.200	639.775	639.100	638.425
	641.500	640.500	639.675	642.500	641.225	640.400
	643.575	642.225	640.800	644.200	642.550	643.425
	645.050	644.725	642.450	645.600	644.575	645.475
	647.425	646.350	643.750	646.700	646.900	647.775
	649.200	647.550	646.200	648.250	650.500	651.675
	652.450	650.800	648.325	649.500	651.750	653.800
	653.650	652.575	652.225	653.100	653.300	656.250
	655.275	654.950	654.525	655.425	654.400	657.550
	657.775	656.425	656.575	657.450	655.800	659.200
	659.500	658.500	659.600	658.775	657.500	660.325
	660.750	661.600	661.575	660.900	660.225	661.800
	Full Range - even distribution for each TV-CH	Full Range - even distribution for each TV-CH	Full Range - max. # of frequencies for CH- 42	Full Range - max. # of frequencies for CH- 43	Full Range - max. # of frequencies for CH- 44	Full Range - max. # of frequencies for CH- 45

	702.200	703.750	703.650	702.750	703.750	702.100	704.775	702.300
	704.200	705.975	705.650	704.500	705.750	704.025	706.225	704.975
	707.200	707.200	708.650	705.750	708.250	705.500	710.500	706.775
	709.425	708.850	710.875	708.250	711.750	708.500	712.025	709.100
	711.000	710.950	712.450	711.250	714.500	710.100	714.225	710.300
	713.675	712.425	715.125	712.500	715.750	712.025	716.900	712.225
	715.575	714.325	717.025	715.250	718.750	713.500	718.500	714.775
	717.050	717.000	718.500	718.750	721.250	717.300	720.775	716.700
	719.150	718.575	720.600	721.250	722.500	725.300	725.300	724.000
	720.800	720.800	722.250	723.250	724.250			725.900
	722.025	723.800	723.475					
	724.250	725.800	725.700					
	Full Range - max. # of compatible frequencies	Full Range - max. # of compatible frequencies	Full Range - max. # of compatible frequencies	France preferred: User Group A	France preferred: User Group A	France preferred: User Group B	France preferred: User Group B	France preferred: User Group C

	703.000	702.200	710.200	718.200	702.550	702.100	702.700	702.500
	706.025	703.300	711.300	719.300	705.600	704.700	704.700	705.500
	708.000	704.700	712.700	720.700	707.500	710.300	709.450	707.000
	710.300	705.800	713.800	721.800	709.000	712.400	711.500	712.200
	712.225	707.675	715.675	723.675	711.500	714.000	714.500	714.100
	716.000	708.775	716.775		715.100	716.500	716.550	716.400
	717.100				717.000	719.400	719.900	719.500
	719.000				720.000	721.300	722.000	722.200
	720.225				723.500		724.700	
	722.775				725.900		725.900	
	724.700							
	France preferred: User Group C	Optimized TV channels: TV ch. 50 702-710 MHz	Optimized TV channels: TV ch. 51 710-718 MHz	Optimized TV channels: TV ch. 52 718-724 MHz	Compatible setup for use with PSM400-P3 (P4 > P3)	Compatible setup for use with PSM400-P3 (P4 = P3)	Compatible setup for use with PSM400-HF (P4 > HF)	Compatible setup for use with PSM400-HF (P4 = HF)

	801.250	801.225	800.950	800.525	801.475	800.600	800.650	
	804.825	804.800	802.950	801.925	803.025	802.050	803.125	
	806.975	806.950	804.325	803.650	805.800	804.275	804.450	
	808.800	808.775	806.425	804.850	806.950	805.750	806.150	
	810.325	810.300	808.050	807.400	809.125	806.850	807.250	
	811.550	811.525	809.275	808.525	810.575	808.550	808.725	
	813.175	813.150	810.800	810.275	811.725	809.875	810.950	
	815.275	815.250	812.625	811.550	813.800	812.350	812.400	
	816.650	816.625	814.775	813.775		813.450	813.500	
	818.650	818.625	818.350					
	819.750	819.800	819.775					
	Full Range - max. # of comp. Frequencies & FIN /NOR /DEN	Full Range - max. # of comp. Frequencies & FIN /NOR /DEN	Full Range - max. # of comp. Frequencies & FIN /NOR /DEN	Germany preferred: User Group 4 800-814 MHz	Germany preferred: User Group 4 800-814 MHz	Sweden preferred: 800-814 MHz	Sweden preferred: 800-814 MHz	

	806.000	806.025	801.400	800.900	801.200	803.850	806.150	
	807.100	807.425	808.300	802.100	803.800	807.000	811.650	
	808.500	808.525	816.400	806.200	805.900	809.700	814.400	
	809.600	810.400		809.300	807.000	811.050	816.500	
	811.475	811.500		814.100	809.200	813.900	817.450	
	812.575	812.900		816.100	811.700	816.500	819.300	
	813.975	814.000		817.200		817.600		
				819.600		819.500		
	Netherlands preferred: TV ch. 63 806-814 MHz	Netherlands preferred: TV ch. 63 806-814 MHz	Compatible setup for use with EUT-TL-TV (R5 > TL-TV)	Compatible setup for use with PSM400- MN (R5 > MN)	Compatible setup for use with PSM400-MN (R5 = MN)	Compatible setup for use with PSM200-R8 (R5 > R8)	Compatible setup for use with PSM200-R8 (R5 = R8)	

	838.200	838.150	838.550	854.200	855.475	855.075	854.750	854.750
	841.450	839.375	839.775	855.300	857.425	857.775	855.850	855.850
	843.275	841.300	841.700	856.700	860.600	860.725	857.250	857.250
	846.225	842.475	842.875	857.800			858.350	858.350
	847.350	846.400	846.800	859.675			860.225	860.225
	850.125	848.025	848.425	860.775			861.325	861.325
	852.575	850.025	850.425					
	854.575	852.475	852.875					
	856.200	855.250	855.650					
	860.125	856.375	856.775					
	861.300	859.325	859.725					
	863.225	861.150	861.550					
	864.450	864.400	864.800					
	Full Range - max. # of compatible frequencies	Full Range - max. # of compatible frequencies	Full Rangemax. # of compatible frequencies	BEL /TUR preferred: opt TV ch.69 854-862 MHz	U.K. preferred: "CH69 Coordinated" SET 1	U.K. preferred: "CH69 Coordinated" SET 2 or SET 3	U.K. preferred: "Co-ordinated frequencies" INDOORS	U.K. preferred: "Co-ordinated frequencies" OUTDOORS

	854.425	863.200	838.200	838.900	838.100	838.700	838.400
	855.525	864.500	839.900	842.600	841.100	842.800	840.600
	857.400		841.000	845.900	842.700	844.800	842.100
	858.500		842.375	847.500	847.000	846.300	844.700
	859.900		844.400	848.600	849.200	847.400	846.600
	861.000		846.100	850.100	850.400	849.200	848.100
			847.350	852.100	852.500	851.300	850.700
			849.400	853.300	854.100		851.850
			851.800	855.100	855.300		853.700
			853.200	857.200			
				858.650			
				859.800			
				861.900			
	U.K. preferred: "Co-ordinated frequencies" OUTDOORS	European harmonized band: optimized for 863 - 865 MHz	Compatible setup for use with EUT-TW-TZ (S6 > TW-TZ)	Compatible setup for use with EUT-VR-VT (S6 > VR-VT)	Compatible setup for use with PSM400-KE (S6 > KE)	Compatible setup for use with PSM400-KE (S6 = KE)	Compatible setup for use with PSM200-S5 (S6 > S5)

	740.125	740.125	740.125	740.125
	741.500	741.950	741.225	740.800
	743.375	743.500	742.925	741.825
	744.600	745.675	744.325	743.075
	746.325	747.400	745.425	745.125
	748.500	748.625	746.875	746.575
	750.050	750.500	748.925	747.675
	751.875	751.875	750.175	749.075
			751.200	750.775
			751.875	751.875
	Full Range	Full Range	Full Range	Full Range



**SHURE®**

Shure Incorporated  
5800 West Touhy Avenue  
Niles, IL 60714-4608 USA

Phone: 847-600-2000  
Fax: 847-600-1212 (USA)  
Fax: 847-600-6446  
Email: [info@shure.com](mailto:info@shure.com)

[www.shure.com](http://www.shure.com)

©2012 Shure Incorporated

Shure Europe GmbH  
Jakob-Dieffenbacher-Str. 12,  
75031 Eppingen, Germany

Phone: 49-7262-92490  
Fax: 49-7262-9249114  
Email: [info@shure.de](mailto:info@shure.de)

Shure Asia Limited  
22/F, 625 King's Road  
North Point, Island East  
Hong Kong

Phone: 852-2893-4290  
Fax: 852-2893-4055  
Email: [info@shure.com.hk](mailto:info@shure.com.hk)